

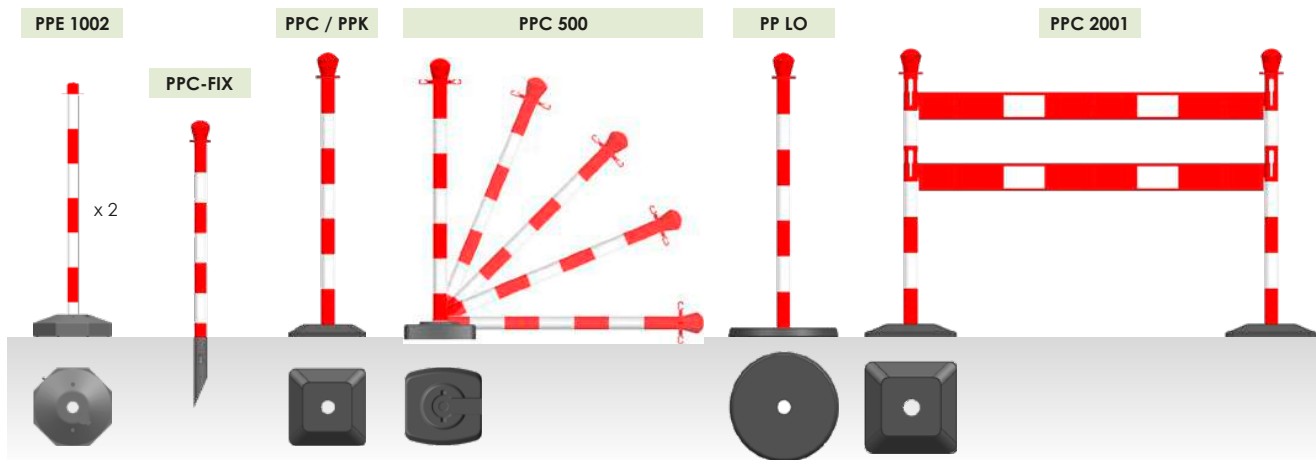

PLASTIQUE ◦ PLASTIC ◦ PLÁSTICO ◦ KUNSTSTOFF

POTEAUX ET BASES ◦ POSTS AND BASES ◦ POSTES Y BASES ◦ PFOSTEN UND BASEN



ACCESSOIRES ◦ ACCESSORIES ◦ ACCESORIOS ◦ ZUBEHÖR

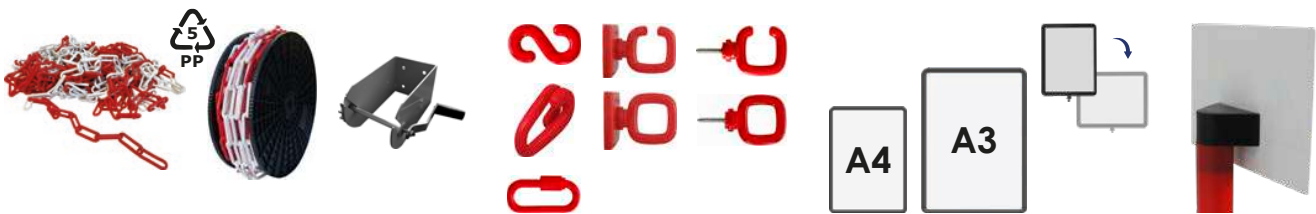

BALISE HAUTE VISIBILITÉ ◦ HIGH VISIBILITY BOLLARD
 BALIZA ALTA VISIBILIDAD ◦ PFOSTEN MIT HOHER SICHTBARKEIT

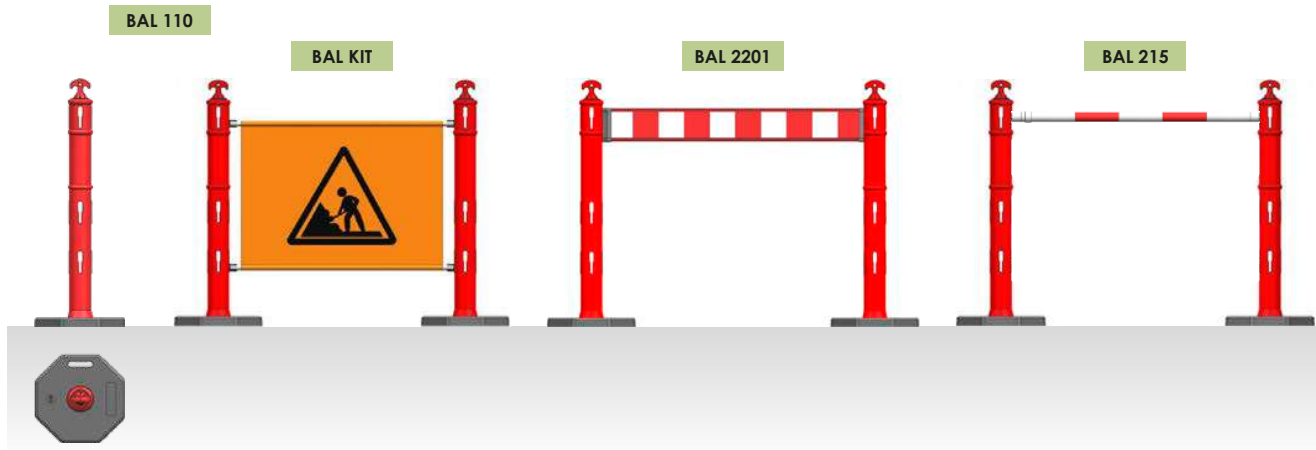



POTEAU DE BALISAGE PREMIUM

SIGN POST ◦ POSTE DE BALIZAMIENTO

KETTENSTÄNDER KUNSTSTOFF

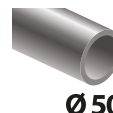

Code	
PPC 40 RB	
PPC 40 NJ	
PPC 40 BU	
PPC 40 VE	
PPK 40 RB	
PPK 40 NJ	
PPK 40 BU	
PPK 40 VE	

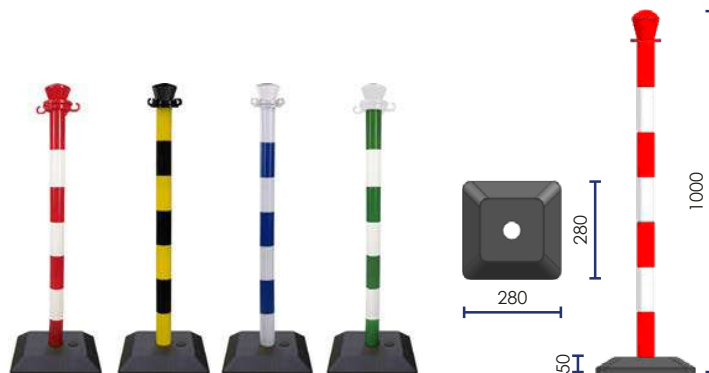
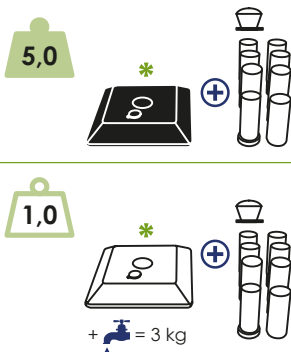

Code	
PPC 1001 RB	
PPC 1001 NJ	
PPC 1001 B	
PPC 1001 G	
PPC 1001 N	
PPC 3001 RB	
PPC 3001 NJ	
PPC 3001 B	
PPC 3001 G	
PPC 3001 N	

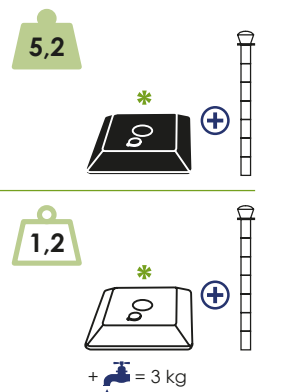

* Base lestée ◦ Loaded base ◦ Base lastrada ◦ Beschwertem Standfuß

Base vide ◦ Empty base ◦ Base vacía ◦ Leerer Standfuß + = 3 kg

OPTION* ◦ OPTIONAL ◦ OPCIÓN ◦ OPTIONAL * ▶ p. 175



KIT POTEAUX CHAINE

POST & CHAIN KIT ◦ KIT DE POSTES CON CADENA
KETTENSTÄNDER SATZ

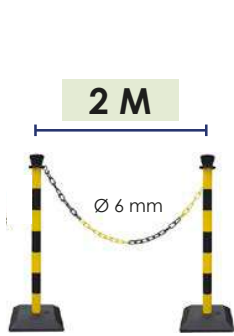
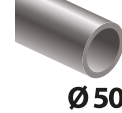

Code
CBR SET RB
CBR SET NJ
CBR SET BB
CBR SET NN
CBR SET GB
PPC 3002 RB
PPC 3002 NJ
PPC 3002 BB
PPC 3002 NN
PPC 3002 GB

10,6

x 2

2 m

2,6

x 2

2 m

+ = 3 kg

Code
PPC SET 40 RB
PPC SET 40 NJ
PPC SET 40 VB
PPC SET 40 BB
PPK SET 40 RB
PPK SET 40 NJ
PPK SET 40 VB
PPK SET 40 BB

10,2

x 2

2 m

2,2

x 2

2 m

+ = 3 kg

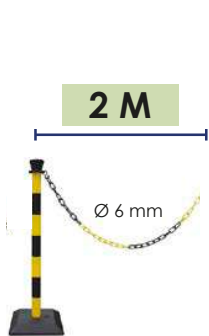

Code
CBR EXT RB
CBR EXT NJ
CBR EXT BB
CBR EXT NN
CBR EXT GB
PPC 3 EXT RB
PPC 3 EXT NJ
PPC 3 EXT BB
PPC 3 EXT NN
PPC 3 EXT GB

5,4

x 1

2 m

1,4

x 1

2 m

+ = 3 kg

Code
PPC EXT RB
PPC EXT 40 NJ
PPC EXT 40 VB
PPC EXT 40 BB
PPK EXT RB
PPK EXT NJ
PPK EXT 40 VB
PPK EXT 40 BB

5,2

x 1

2 m

1,2

x 1

2 m

+ = 3 kg

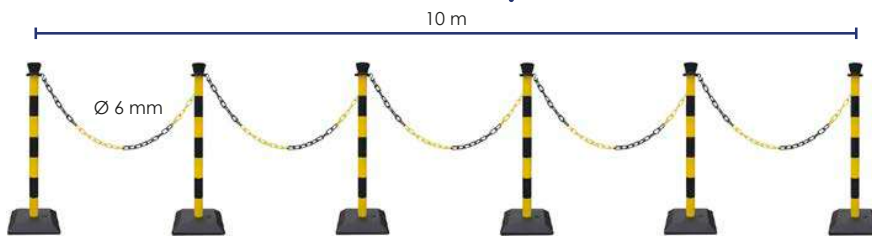

Code
CBR 6 SET
CBR 6 SET NJ
CBR 6 SET BB
CBR 6 SET NN
CBR 6 SET GB
PPC 3006 RB
PPC 3006 NJ
PPC 3006 BB
PPC 3006 NN
PPC 3006 GB

31,7

x 6

10 m

7,7

x 6

10 m

+ = 3 kg

Code
PPC SET 406 RB
PPC SET 406 NJ
PPC SET 406 VB
PPC SET 406 BB
PPK SET 406 RB
PPK SET 406 NJ
PPK SET 406 VB
PPK SET 406 BB

30,5

x 6

10 m

6,5

x 6

10 m

+ = 3 kg

* Base lestée ◦ Loaded base
Base lastrada ◦ Beschwertem Standfuß

* Base vide ◦ Empty base ◦ Base vacía ◦ Leerer Standfuß + = 3 kg

** Chaîne blanche ◦ White chain ◦ Cadena blanca ◦ Kettenfarbe weiß

PPC-FIX

POTEAU DE BALISAGE ◦ SIGNPOST POSTE DE BALIZAMIENTO ◦ KETTENSTÄNDER

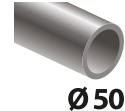

ABS

Ø 50

À PLANTER ◦ WITH STAKE ◦ CON ESTACA ◦ VERSION : BODENBEFESTIGUNG

Code	
PPC-FIX RB	
PPC-FIX VB *	
PPC-FIX BB *	
PPC-FIX NJ	
PPC-FIX B	
PPC-FIX G	
PPC-FIX N	

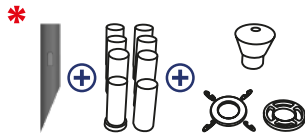
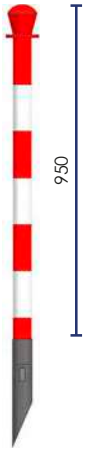
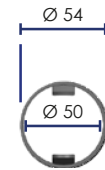
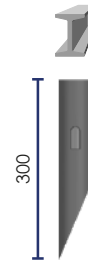
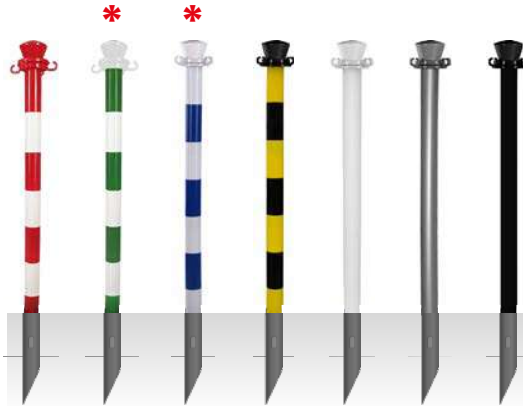

BASE LOURDE ◦ HEAVY BASE ◦ BASE PESADA ◦ VERSION : STANDFUSS

Code	
PPLO 100 RB	
PPLO 100 NJ	
PPLO 100 B	
PPLO 100 G	
PPLO 100 N	
PPVD 100 RB	
PPVD 100 NJ	
PPVD 100 B	
PPVD 100 G	
PPVD 100 N	

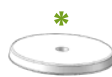
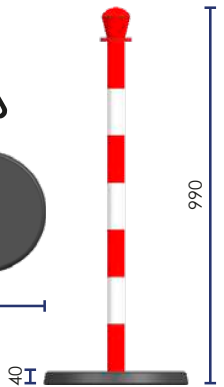
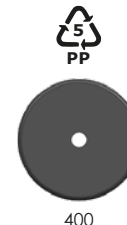

+ = 4 kg

* Base lestée ◦ Loaded base
Base lastrada ◦ Beschwertem Standfuß

Base vide ◦ Empty base ◦ Base vacía ◦ Leerer Standfuß + = 4 kg

OPTION* ◦ OPTIONAL ◦ OPCIÓN ◦ OPTIONAL * ▶ p. 175

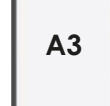
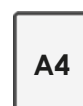



PPC 2001

POTEAU DE BALISAGE PLIANT
FOLDABLE SIGNPOST ◦ **POSTE DE BALIZAMIENTO PLEGABLE**
VERSION : ZUSAMMENLEGBAR

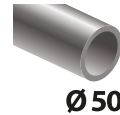

Code	
PPC 500 LOVB *	
PPC 500 LOBB *	
PPC 500 LOG	
PPC 500 LOB	
PPC 500 LONJ	
PPC 500 LON	
PPC 500 LOVB *	
PPC 500 VB *	
PPC 500 BB *	
PPC 500 G	
PPC 500 B	
PPC 500 NJ	
PPC 500 N	
PPC 500 RB	

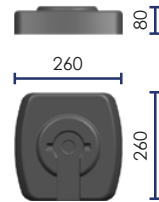
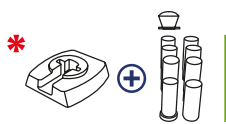
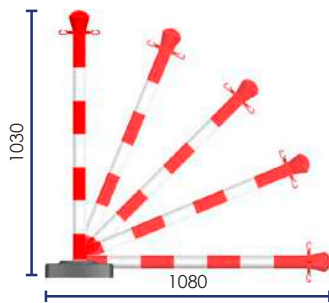

* Base lestée ◦ Loaded base
 Base lastrada ◦ Beschwertem Standfuß

Base vide ◦ Empty base ◦ Base vacía ◦ Leerer Standfuß + = 2,6 kg

BARRICADE ◦ **BARRIERS** ◦ **BARRERAS** ◦ **ABSPERRUNG**

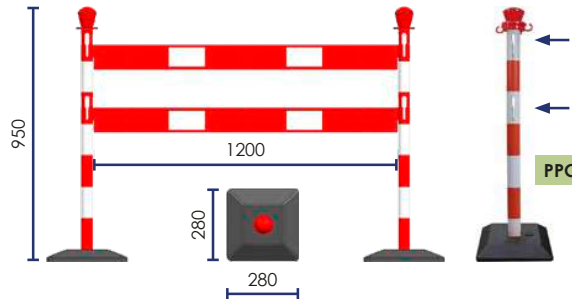
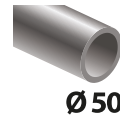
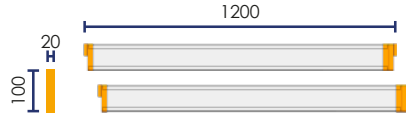

PPC 2001 RB



PPE

PPC A3 / A4

POTEAU D'INFORMATION ◦ **INFORMATION POST**
POSTE DE INFORMACIÓN ◦ **INFO-STÄNDER KUNSTSTOFF**



Code	
PPC A4 RB	
PPC A4 NJ	
PPC A4 B	
PPC A4 G	
PPC A4 N	
PPC A4 BB *	
PPC A4 VB *	

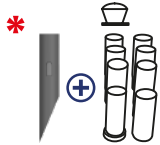
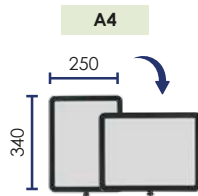

Base lestée
 Loaded base
 Base pesada
 Beschwertem standfuß

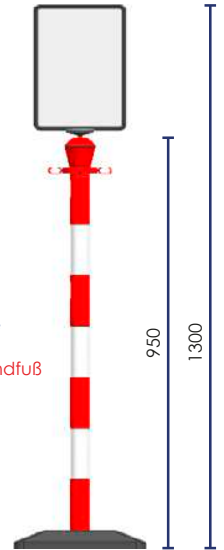
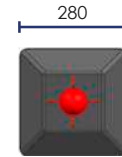

POTEAU PLASTIQUE BUDGET
BUDGET PLASTIC POST ◦ **POSTE PLÁSTICO**
KETTENSTÄNDER KUNSTSTOFF



Code					kg
PPE 1002 RB		2	-	-	1,2
PPE 2100 RB		2	2 m	2	1,6
PPE 6100 RB		6	10 m	10	6,2

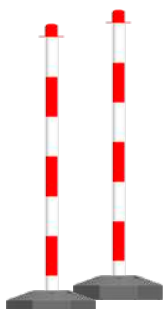
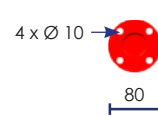

PPE 1002 RB



PPE 2100 RB

2 m / Ø 6 mm ——— + 2 x

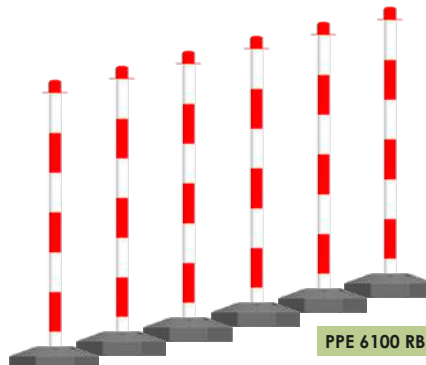

PPE 6100 RB

10 m / Ø 6 mm ——— + 10 x

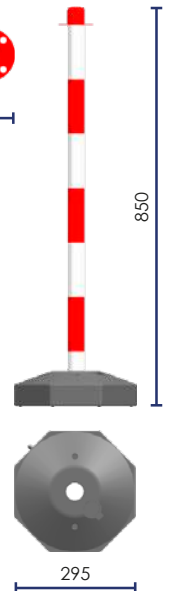



ACCESSOIRES ◦ ACCESSORIES ◦ ACCESORIOS ◦ ZUBEHÖR



Code		∅	↔
CBR 625 NP		6	2
CBR 610 FAB			10
CBR 601 SBS			25
CNJ 625 FAB			2
CNJ 610 FAB			10
CNJ 601 SBS			25
CFLUO 825 SBS		8	25
CPB 820 NP			2
CPB 801 SBS			25
CPJ 801 SBS *			25
CNJ 820 NP			2
CNJ 801 SBS			25
CPN 820 FAB			2
CPN 801 SBS			25
CBR 820 NP			2
CBR 805 SB			5
CBR 810 SB		10	
CBR 801 SBS		25	
CMLRB 806 NB **		25	
CMLRB 825 SBS		25	
CPR 801 SBS *		25	
CBV 820 SB		2	
CBV 801 SBS		25	
CBB 820 SB		2	
CBB 801 SBS		25	
CBR 101 SBS		10	25
CNJ 101 SBS			25

C FLUO 825 SBS

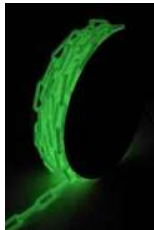

DVD 350

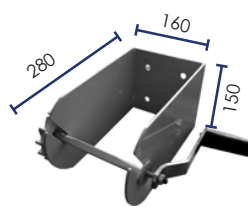

CMLRB 806 NB **



Avec blocage
Livré sans fixation
With stop
No fixation included
Con bloqueo
No incluye fijaciones
Mit Blockierung
Ohne Fixierung

Code		∅	
MRP 602 NP		6	1 ● + 1 ○
MRR 604 SB			x 4
MRN 604 SB			x 4
MRB 604 SB			x 4
MRP 802 NP		8	1 ● + 1 ○
MRB 804 SB			x 4
MRN 804 SB			x 4
MRR 804 SB			x 4
MRB 1004 SBS		10	x 4
MRN 1004 SBS			x 4
MRR 1004 SBS			x 4
APR 804 SB			x 4
APN 804 SB		8	x 4
APB 804 SB			x 4
EPR 804 SB			x 4
EPN 804 SB			x 4
EPB 804 SB		8	x 4
ERB 804 SB			2 ● + 2 ○

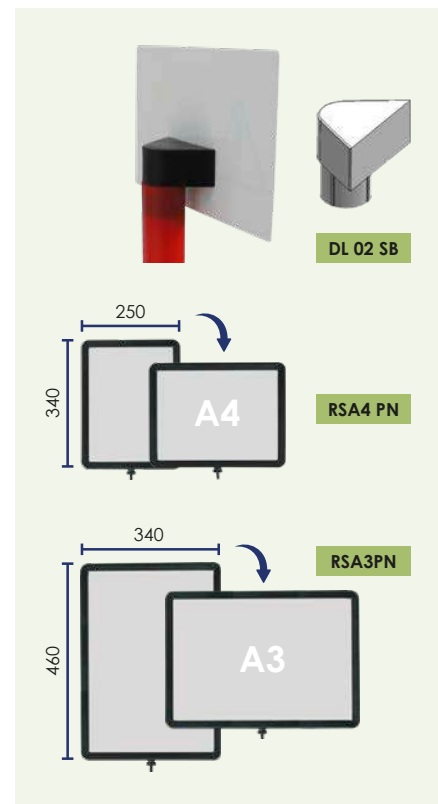

Code		∅	
CRO 004 SB			x 4
CNO 004 SB			
CBO 004 SB			
CRF 004 SB			
CNF 004 SB			x 1
CBF 004 SB			
APF 801 R SB			
APF 801 N SB			
APF 801 B SB			x 1
APO 801 R SB			
APO 801 N SB			
APO 801 B SB			

* Jusqu'à épuisement du stock ◦ While stock lasts ◦ Hasta agotar existencias ◦ Solange der Vorrat reicht

BAL 110

BALISE HAUTE VISIBILITÉ ○ HIGH VISIBILITY BOLLARD
BALIZA ALTA VISIBILIDAD ○ PFOSTEN MIT HOHER SICHTBARKEIT



CAOUTCHOUC VULCANISÉ
 VULCANIZED RUBBER
 CAUCHO VULCANIZADO
 VULKANISIERTEM KAUSCHUK

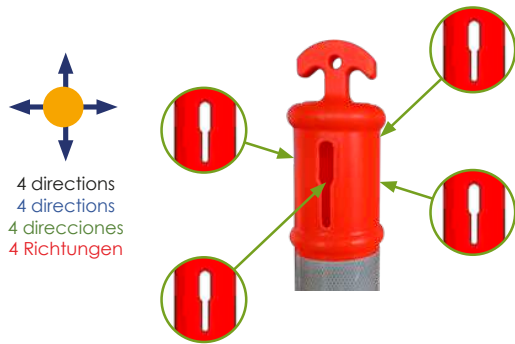

OPTION ○ OPTIONAL ○ OPCIÓN ○ OPTIONAL





KIT CHAINE ○ **CHAIN KIT**
KIT CON CADENA ○ **SET PFOSTEN MIT KETTEN**



CAOUTCHOUC VULCANISÉ
 VULCANIZED RUBBER
 CAUCHO VULCANIZADO
 VULKANISIERTEM KAUSCHUK

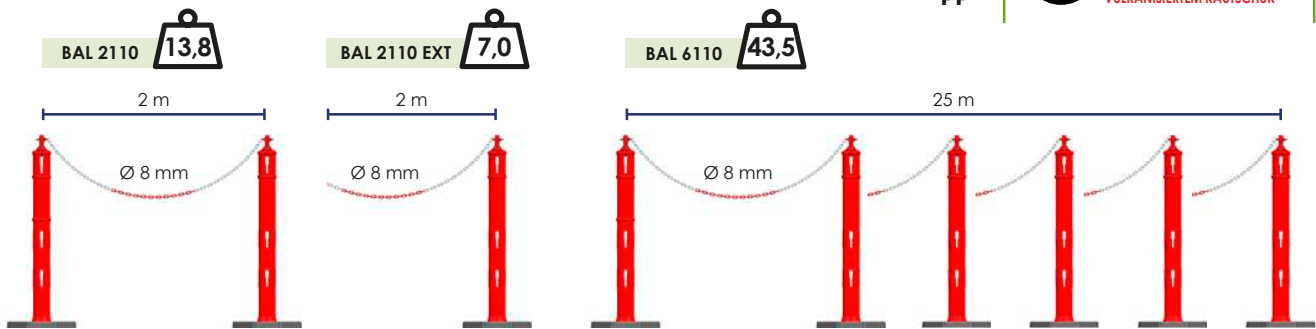

OPTION ○ **OPTIONAL** ○ **OPCIÓN** ○ **OPTIONAL**

	25 m / Ø 6 mm	CBR 601 SBS
	25 m / Ø 8 mm	CBR 801 SBS
	25 m / Ø 10 mm	CBR 101 SBS



KIT BARRE EXTENSIBLE ○ **EXPANDABLE BARRIER KIT**
KIT BARRERA EXTENSIBLE
SET ABSPERRPFOSTEN MIT ABSPERRSTANGEN



CAOUTCHOUC VULCANISÉ
 VULCANIZED RUBBER
 CAUCHO VULCANIZADO
 VULKANISIERTEM KAUSCHUK

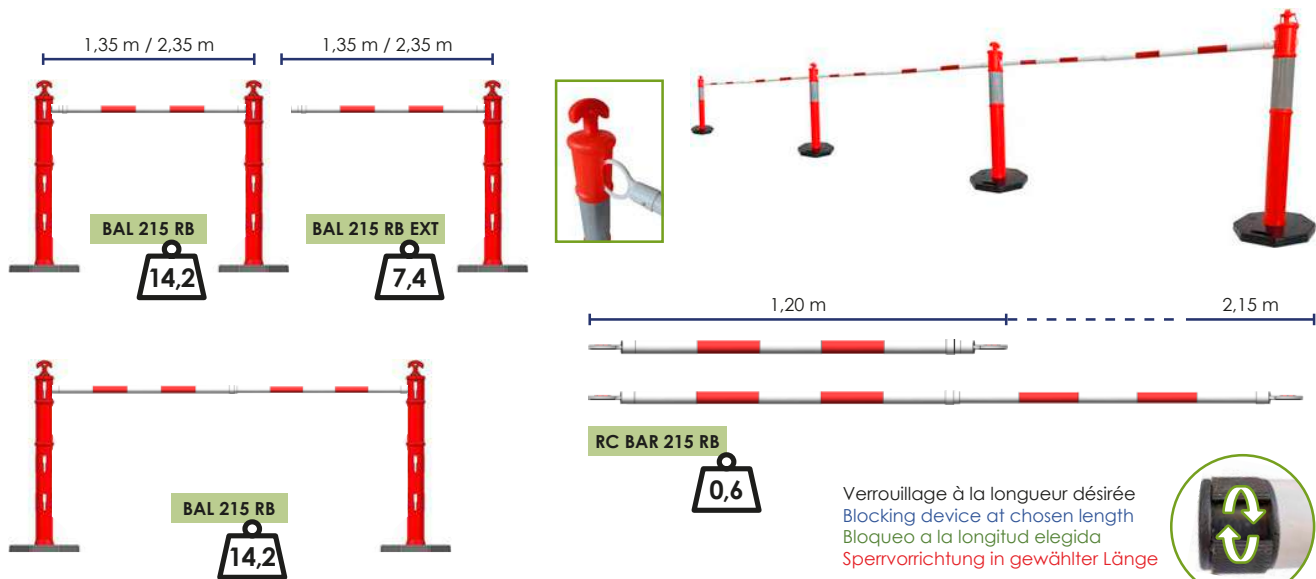

Verrouillage à la longueur désirée
 Blocking device at chosen length
 Bloqueo a la longitud elegida
 Sperrvorrichtung in gewählter Länge





KIT BARRIÈRE EXTENSIBLE ○ **EXPANDABLE BARRIER KIT**
KIT CON BARRERAS EXTENSIBLES ○ **SET ABSPERRPFOSTEN MIT LATTEN**



CAOUTCHOUC VULCANISÉ
VULCANIZED RUBBER
CAUCHO VULCANIZADO
VULKANISIERTEM KAUTSCHUK

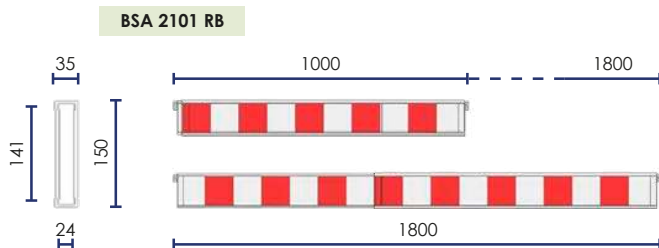
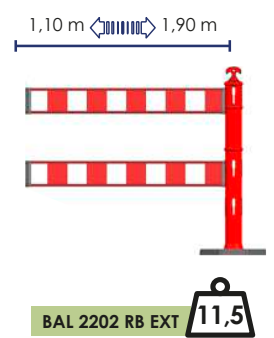
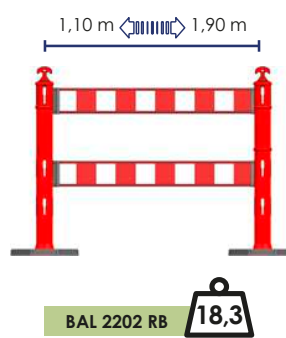
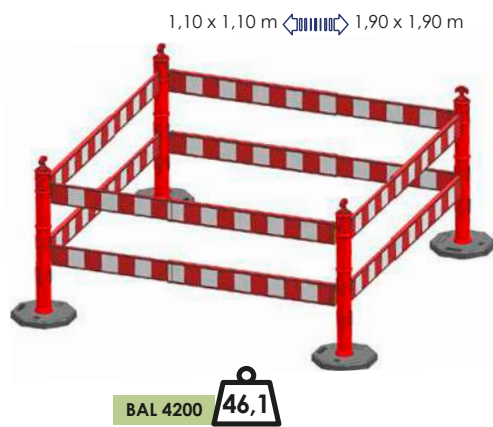
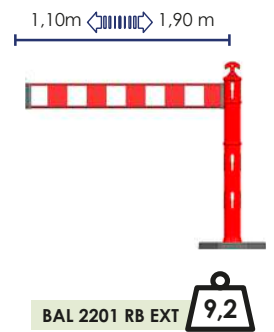
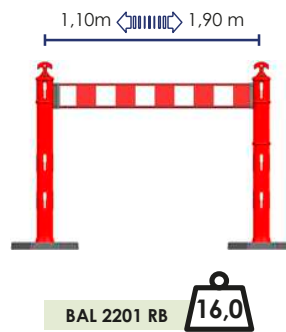
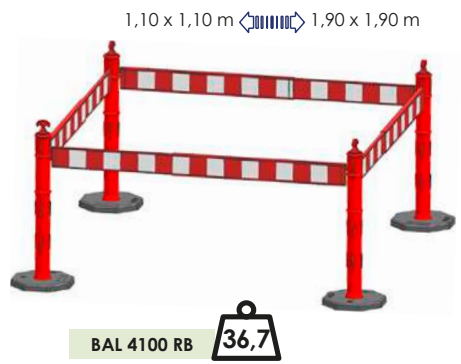

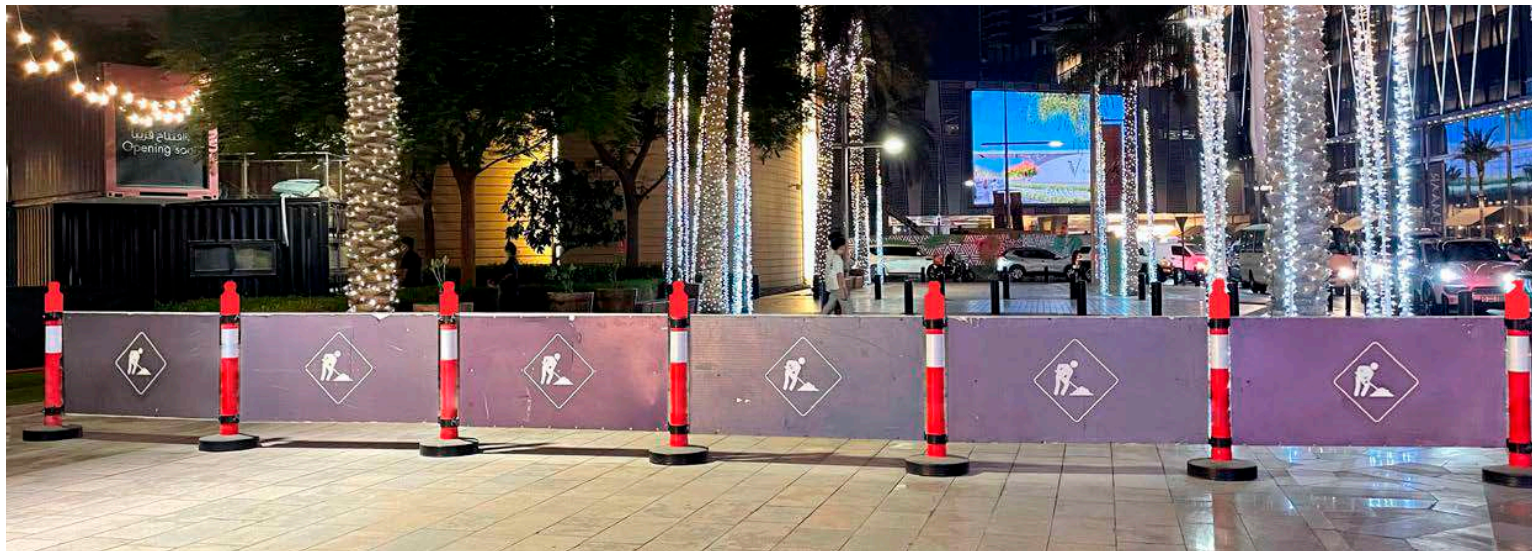

KIT BÂCHE ◦ TARPULIN KIT KIT CON LONA ◦ SET ABSPERRPFOSTEN MIT PLANE



CAOUTCHOUC VULCANISÉ
VULCANIZED RUBBER
CAUCHO VULCANIZADO
VULKANISIERTEM KAUTSCHUK



Toile PP enduit PVC
PVC coated polypropylene fabric
Lona de PP recubierta de PVC
PVC beschichtete Polyestergewebe

Imprimé 1 face
1 side printed
Impreso a 1 cara
1 seite ist bedruckt

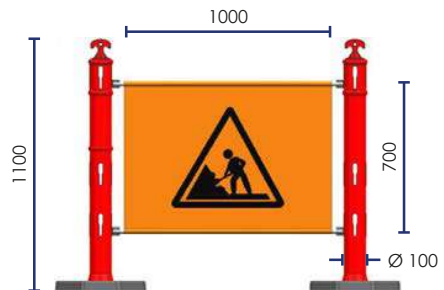

BÂCHE PERSONNALISÉE ◦ CUSTOMIZED TARPULIN LONA PERSONALIZADA ◦ KUNDENSPEZIFISCHE PLANEN

Minimum 5 barrières ◦ Minimum order 5 barriers
Pedido mínimo: 5 barreras
Mini Bestellungen 5 Absperungen



Toile PP enduit PVC
PVC coated polypropylene fabric
Lona de PP recubierta de PVC
PVC beschichtete Polyestergewebe

Choix de couleur de fond, impression 4 couleurs
Background to customer choice, 4 colors print
Elección del color del fondo, impresión a 4 colores
Wahl der Hintergrundfarbe, 4-farbiger Druck

BÂCHE BRISE VENT ◦ WIND BREAK TARPULIN LONA CORTAVIENTOS ◦ WINDFESTE PLANE

Minimum 5 barrières ◦ Minimum order 5 barriers
Pedido mínimo: 5 barreras
Mini Bestellungen 5 Absperungen



Bâche brise vent microperforée
Microperforation wind break tarpaulin
Lona cortavientos microperforada
Mikroperforierte Windschutzhülle

Choix de couleur de fond, impression 4 couleurs
Background to customer choice, 4 colors print
Elección del color del fondo, impresión a 4 colores
Wahl der Hintergrundfarbe, 4-farbiger Druck



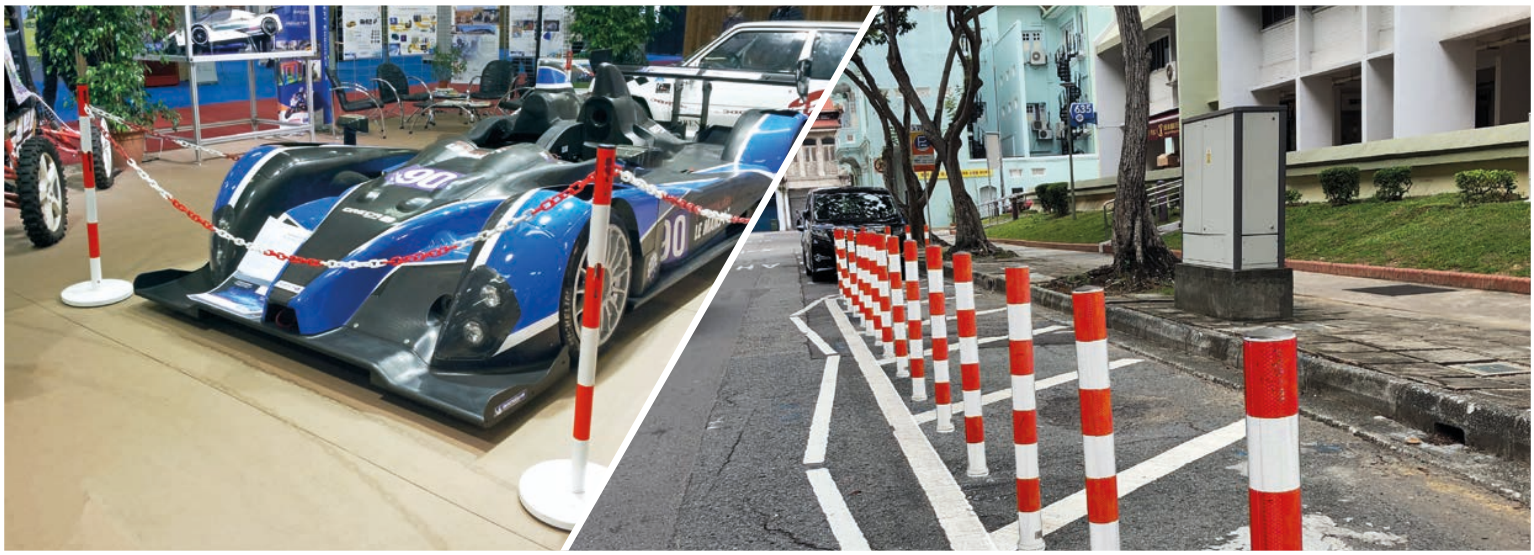

ACIER ◦ **STEEL** ◦ **ACERO** ◦ **STAHL**



POTEAUX ET BASES ◦ **POSTS AND BASES** ◦ **POSTES Y BASES** ◦ **PFOSTEN UND BASEN**

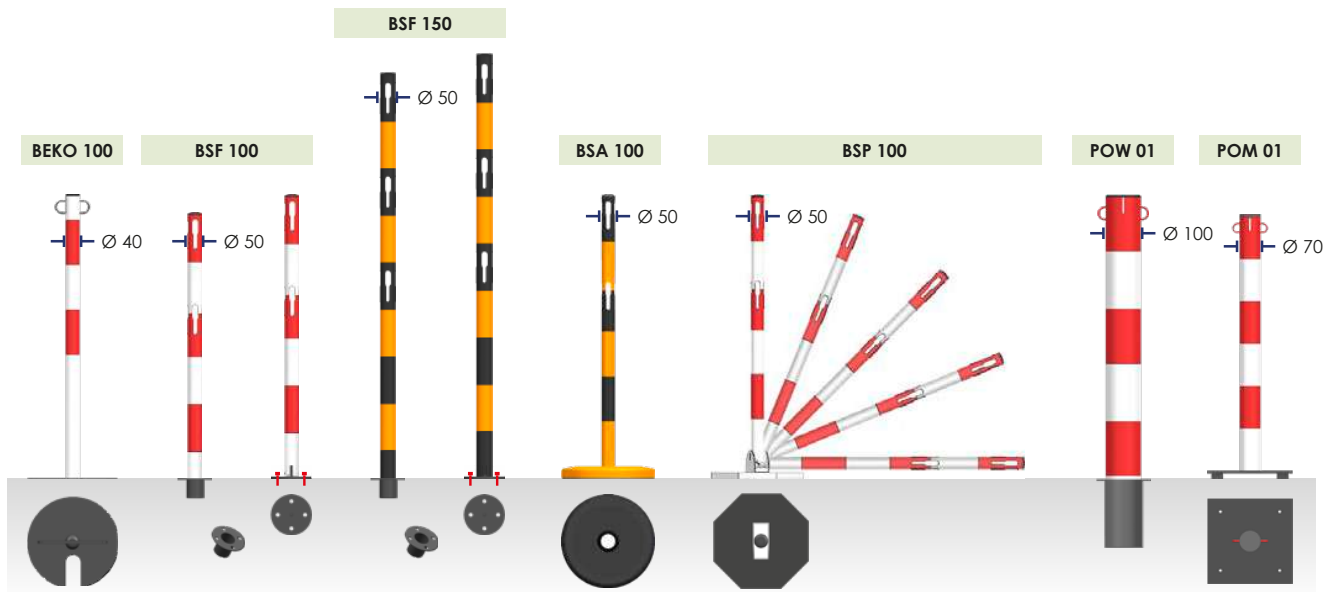

KITS

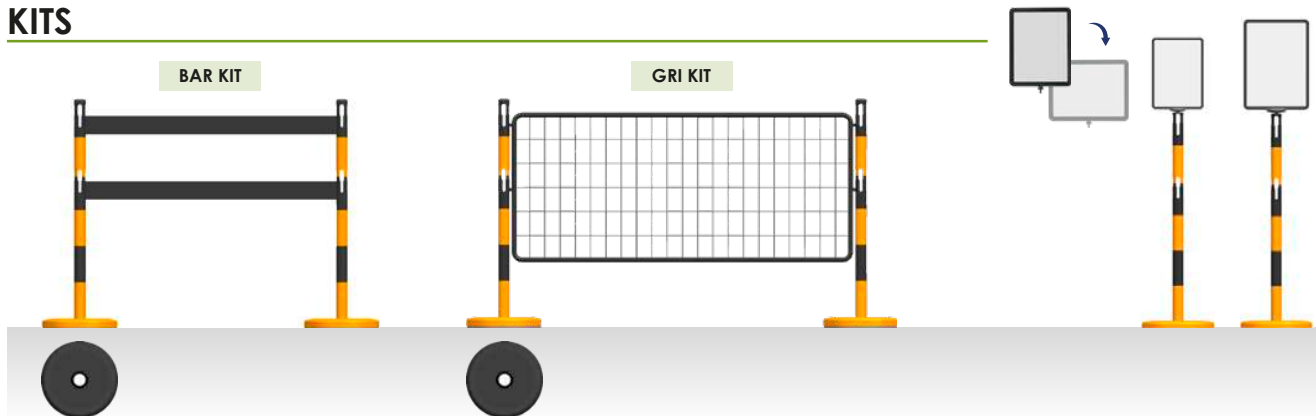

ACCESSOIRES ◦ **ACCESSORIES** ◦ **ACCESORIOS** ◦ **ZUBEHÖR**





BSA

POTEAU ACIER BASE LESTÉE

STEEL POST WITH LOADED BASE ◦ POSTE DE ACERO CON BASE PESADA
 KETTENSTÄNDER AUS STAHL MIT SCHWERE BASISPLATTE

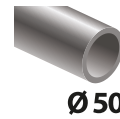

BSA 100 AISI

Code	
BSA 100 AISI *	
BSA 100 B	
BSA 100 N	
BSA 100 RB	
BSA 100 NJ	



BSA 100



2 niveaux
2 levels
2 niveles
2 Aufhängenhöhen



4 directions
4 directions
4 direcciones
4 Anschlüsse

INCLUS ◦ INCLUDED ◦ INCLUIDO ◦ INKLUSIVE



OPTION ◦ OPTIONAL ◦ OPCIÓN ◦ OPTIONAL

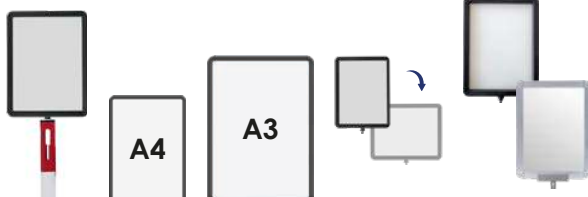

Code		
RS A4 PN		
RS A3 PN		
RS A4		
RS A3		





BSP 100



BSF

POTEAU DE BALISAGE
SIGN POST ◦ **POSTE DE BALIZAMIENTO**
KETTENSTÄNDER



4 directions
 4 directions
 4 direcciones
 4 Richtungen

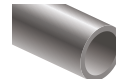

Ø 50



BSF 100 AISI

À FIXER ◦ **TO FIX** ◦ **FIJOS** ◦ **ZU BEFESTIGENDEN**

Code	
BSF 100 AISI *	
BSF 100 B	
BSF 100 N	
BSF 100 RB	
BSF 100 NJ	



BSF 100



BSF 150

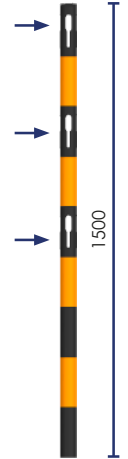
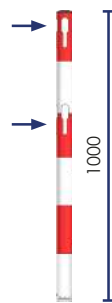

Code	
BSF 150 RB	
BSF 150 NJ	



REPLIABLE ◦ **FOLDABLE** ◦ **PLEGABLE** ◦ **ZUSAMMENLEGBAR**

Code	
BSP 100 B	
BSP 100 RB	
BSP 100 NJ	

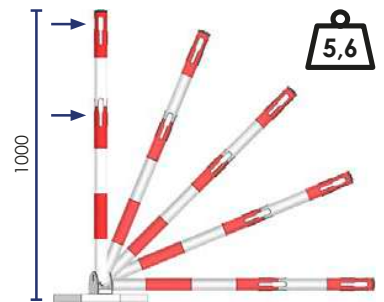
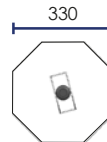

OPTION ◦ **OPTIONAL** ◦ **OPCIÓN** ◦ **OPTIONAL** ▶ **BSF 100 / 150**

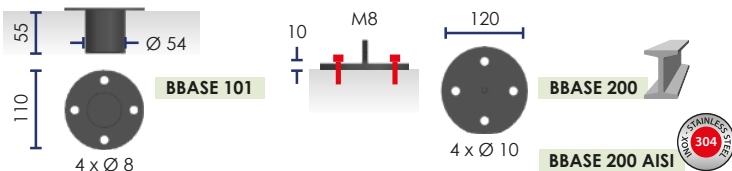

INCLUS ◦ **INCLUDED** ◦ **INCLUIDO** ◦ **INKLUSIVE**





POT 6 KIT

POT 1 KIT

KIT CHAINE ACIER

STEEL CHAIN KIT

KIT CADENA METALICA ◦ SET KETTEN STAHL



4 directions
4 directions
4 direcciones
4 Richtungen

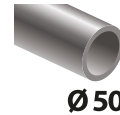

Code	
POT 1 B KIT	○
POT 1 N KIT	●
POT 1 R KIT	◐
POT 1 J KIT	◑
POT 1 AISI KIT *	●

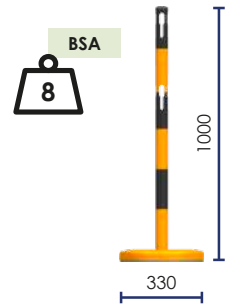

Code	
POT 6 B KIT	○
POT 6 N KIT	●
POT 6 R KIT	◐
POT 6 NJ KIT	◑
POT 6 AISI KIT *	●

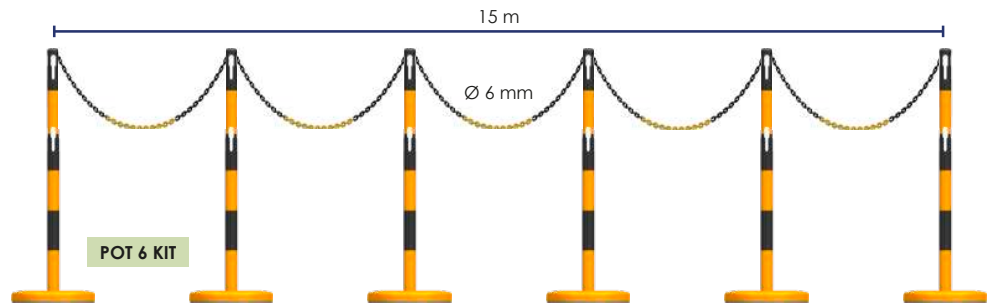

Code	
POT 1 B EXT	○
POT 1 N EXT	●
POT 1 R EXT	◐
POT 1 J EXT	◑
POT 1 AISI EXT *	●

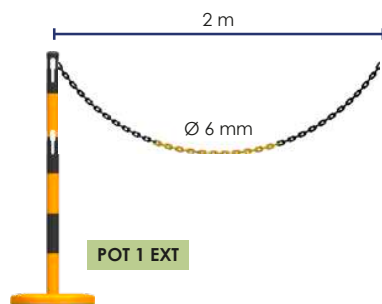

INCLUS ◦ INCLUDED ◦ INCLUIDO ◦ INKLUSIVE



OPTION
OPTIONAL
OPCIÓN
OPTIONAL

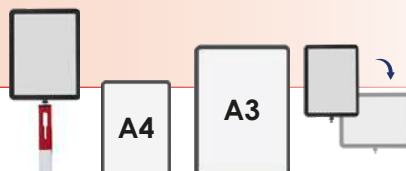

Code	
RS A4 PN	ABS
RS A3 PN	ABS
RS A4	alu
RS A3	alu

* Poteaux et chaîne inox ◦ Stainless steel posts and chain ◦ Postes y cadena en acero inoxidable ◦ Pfosten und Kette aus Edelstahl



GRI KIT

KIT GRILLE POSE LIBRE

FENCE KIT

KIT CON REJA ◦ SET ABSPERRUNG MIT GITTER

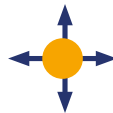

4 directions
4 directions
4 direcciones
4 Richtungen

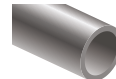

Ø 50



GRI CH -

Code	
GRI CH KIT *	
GRI BK KIT	
GRI RB KIT	
GRI NJ KIT	

27,5

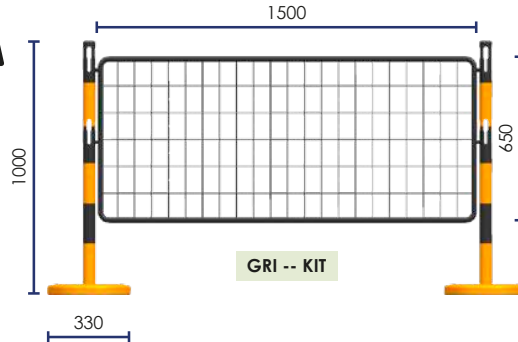

GRI -- KIT



Code	
GRI CH EXT *	
GRI BK EXT	
GRI RB EXT	
GRI NJ EXT	

17,0

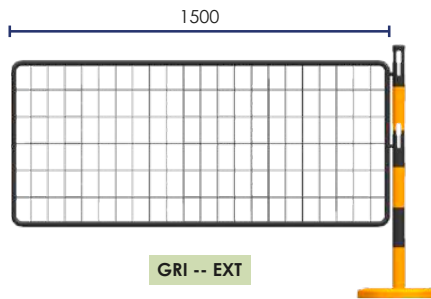

GRI -- EXT



Code	
B 1500 ZG *	ZINGUÉ ZINC ZINCADO VERZINKTE
B 1500 N	
B 1500 R	

6,5

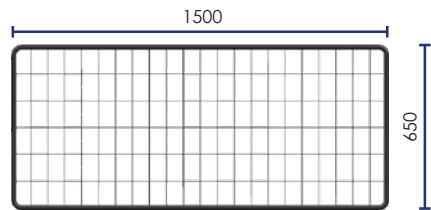

B1500



OPTION ◦ OPTIONAL ◦ OPCIÓN ◦ OPTIONAL

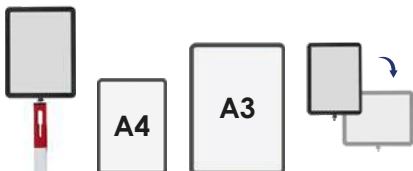

Code	
RS A4 PN	
RS A3 PN	
RS A4	
RS A3	

ABS

alu

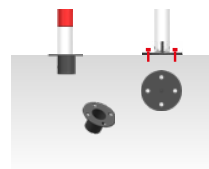

Fixation dans le sol ▶ p. 183
Ground fixing ▶ p. 183
Fijación al suelo ▶ p. 183
Fixierung im Boden ▶ p. 183

* Poteaux inox - Barrière acier zingué ◦ Stainless steel posts - zinc plated fence
Postes de acero inoxidable - valla galvanizada ◦ Pfosten aus Edelstahl - Schranke aus verzinktem Stahl



BAR- KIT

KIT BARRIÈRE POSE LIBRE ◦ BARRIERS KIT KIT CON BARRERAS ◦ SET ABSPERRUNG MIT LATTEN



4 directions
4 direcciones
4 Richtungen

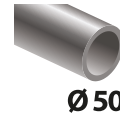

Code	
BAR-CH KIT *	
BAR-BK KIT	
BAR-RB KIT	
BAR-NJ KIT	

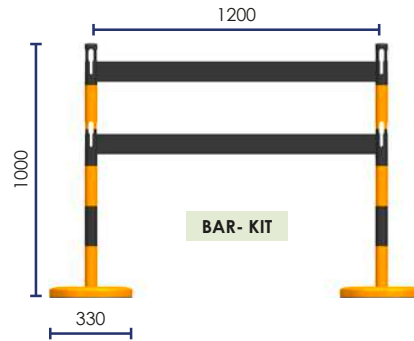

Code	
BAR-CH EXT *	
BAR-BK EXT	
BAR-RB EXT	
BAR-NJ EXT	

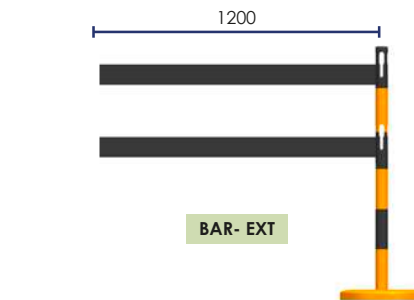

Code	
BSA 1202 ZG *	ZINGUÉ ZINC ZINCADO VERZINKTE
BSA 1202 N	alu
BSA 1202 RB	5 PP

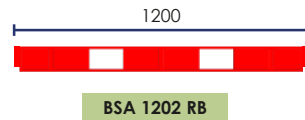
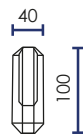

Code	
BSA 2101 RB	5 PP

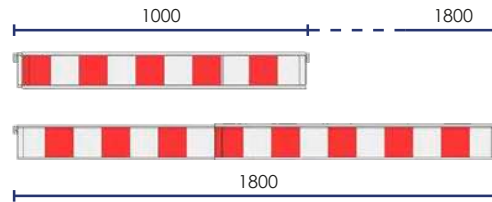
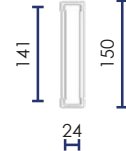

OPTION ◦ OPTIONAL ◦ OPCIÓN ◦ OPTIONAL

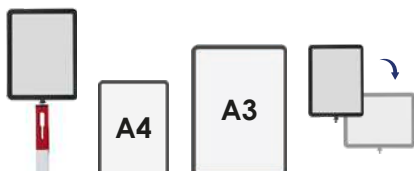

Code	
RS A4 PN	
RS A3 PN	
RS A4	alu
RS A3	

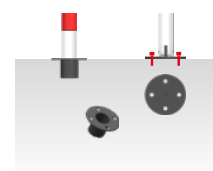

Fixation dans le sol ▶ p. 183
Ground fixing ▶ p. 183
Fijación al suelo ▶ p. 183
Fixierung im Boden ▶ p. 183

* Poteaux inox - Barrière acier zingué ◦ Stainless steel posts - zinc plated barriers
Postes de acero inoxidable - barreras galvanizadas ◦ Pfosten aus Edelstahl - Schranke aus verzinktem Stahl



BEKO

POTEAU EMPILABLE ACIER ◦ **STACKABLE STEEL POST**
POSTE ACERO APILABLE ◦ **KETTENSTÄNDER AUS STAHL**



Code	
BEKO 100 BK	
BEKO 100 RB	
BEKO 100 NJ	

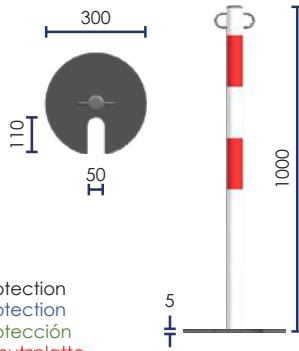

INCLUS ◦ **INCLUDED** ◦ **INCLUIDO** ◦ **INKLUSIVE**



Protection
Protection
Protección
Schutzplatte

OPTION ◦ **OPTIONAL** ◦ **OPCIÓN** ◦ **OPTIONAL**



BBASE 40

BAS 40 SIM GAL

BASOL 40 GAL



RS A4 PN

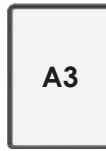

RS A3 PN

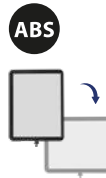

ABS

TUBEKO 100 RB
+ BBASE 40

BEKO 100

POTEAUX D'INFORMATION ◦ **INFORMATION POST**
POSTE DE INFORMACIÓN ◦ **INFO STÄNDER**

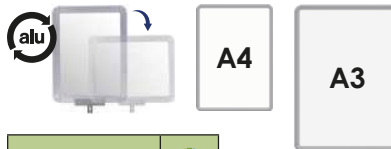

BKI 1004 **6,0**

BSA 1004 **8,7**

BSA 1003 **9,4**

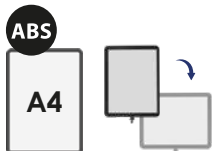

ABS

A4

Code	
BKI 1004 RB	
BKI 1004 NJ	
BKI 1004 B	

A4

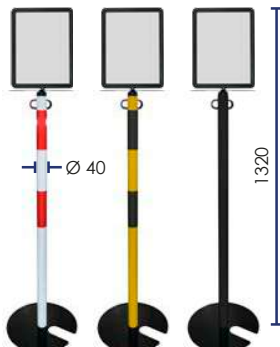

Code	
BSA 1004 RB	
BSA 1004 NJ	
BSA 1004 B	
BSA 1004 N	
BSA 1004 AISI	
BSA 1003 RB	
BSA 1003 NJ	
BSA 1003 B	
BSA 1003 N	
BSA 1003 AISI	

A4

A3





CHAINE ACIER ET ACCESSOIRES ◦ STEEL CHAIN AND ACCESSORIES CADENA DE ACERO Y ACCESORIOS ◦ STAHLKETTEN UND ZUBEHÖR

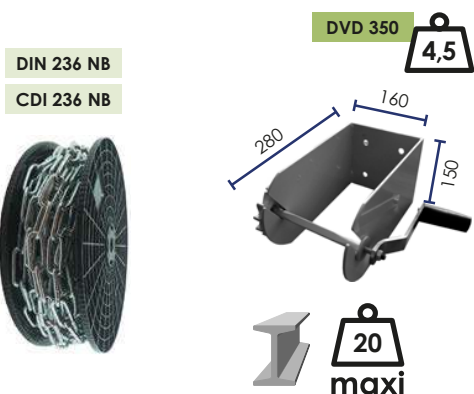

Avec blocage - Livré sans fixation
With stop - No fixation included
Con bloqueo - No incluye fijaciones
Mit Blockierung - Ohne Fixierung



Ø 6

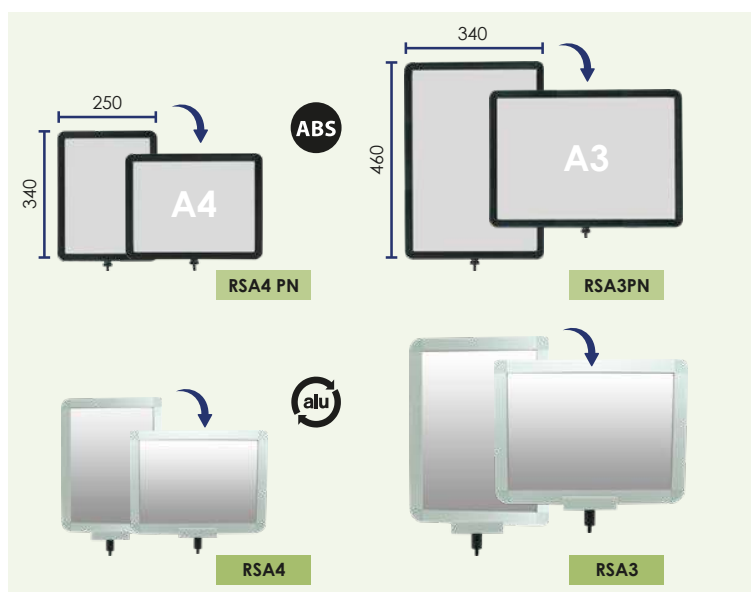

Ø 6



Ø 6

Code	*		↔	kg
DIN 236 NB	2	●		16,5
CDI 236 NB	1	●	25 m	17
NAU 64 NB	3	●		20
DIN 233 RB CT	4	●		9,3
DIN 233 NJ CT	4	●	15 m	9,3
DIN 233 BL CT	4	○		9,3
CDCH 25 SB	5	●		1,4
DIN 225 RB SB	4	●		1,7
DIN 225 NJ SB	4	●	2 m	1,7
DIN 225 B SB	4	○		1,7
DIN 225 N SB	4	●		1,7



Code	*		
MRA 602 NS	2	●	x 2
MRI 602 NS	1	●	x 2
MRAR 604 SB	4	●	x 4
MRAN 604 SB	4	●	x 4

Code	*		
ESS 582 NP	2	●	x 2
ESI 502 NS	1	●	x 2
ESR 584 SB	4	●	x 4
ESW 584 SB	4	○	x 4
ESN 584 SB	4	●	x 4
ESNJ 584 NS	4	●	2 ● + 2 ●



- * 1 ▷ Inox ◦ Stainless steel ◦ Acero inoxidable ◦ Nichtrostend
- 2 ▷ Zingué ◦ Zinc ◦ Zincado ◦ Verzinkte
- 3 ▷ Galva à chaud ◦ Galvanized steel ◦ Acero galvanizado ◦ Nichtrostend
- 4 ▷ Epoxy
- 5 ▷ Chromé ◦ Chromed ◦ Cromado ◦ Verchromte



POW 01 RB

POM 01 RB

POTEAUX SÉRIE LOURDE ◦ **HEAVY DUTY POST**
POSTES ALTA RESISTENCIA ◦ **METALL PFOSTEN – « BIG » AUSFÜHRUNG**



PEINTURE ÉPOXY
 POWDER PAINTING
 PINTURA EPOXICA
 EPOXY FARBE



DIN 233 RB CT



DIN 225 RB SB

Ø 6

Code	*			
DIN 233 RB CT	4		15 m	9,3
DIN 225 RB SB	4		2 m	1,7

* 4 ▷ Epoxy

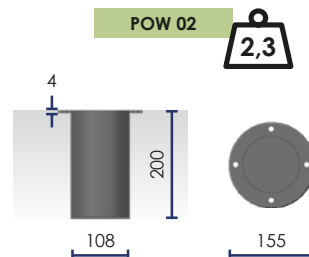
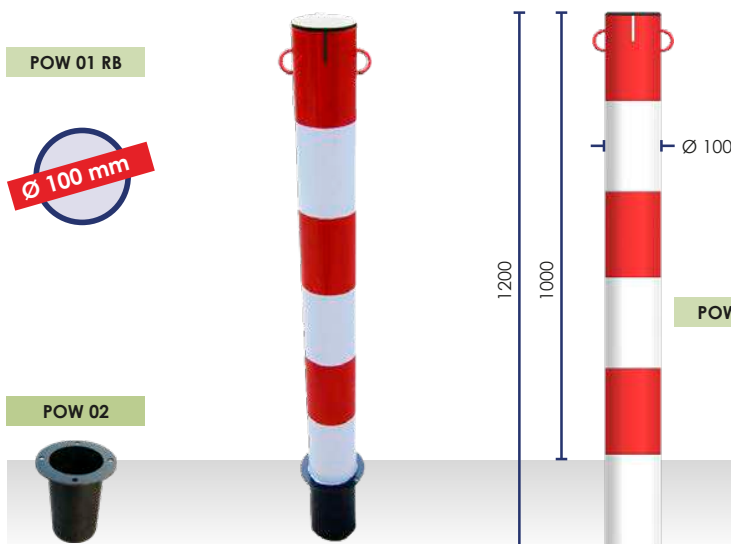

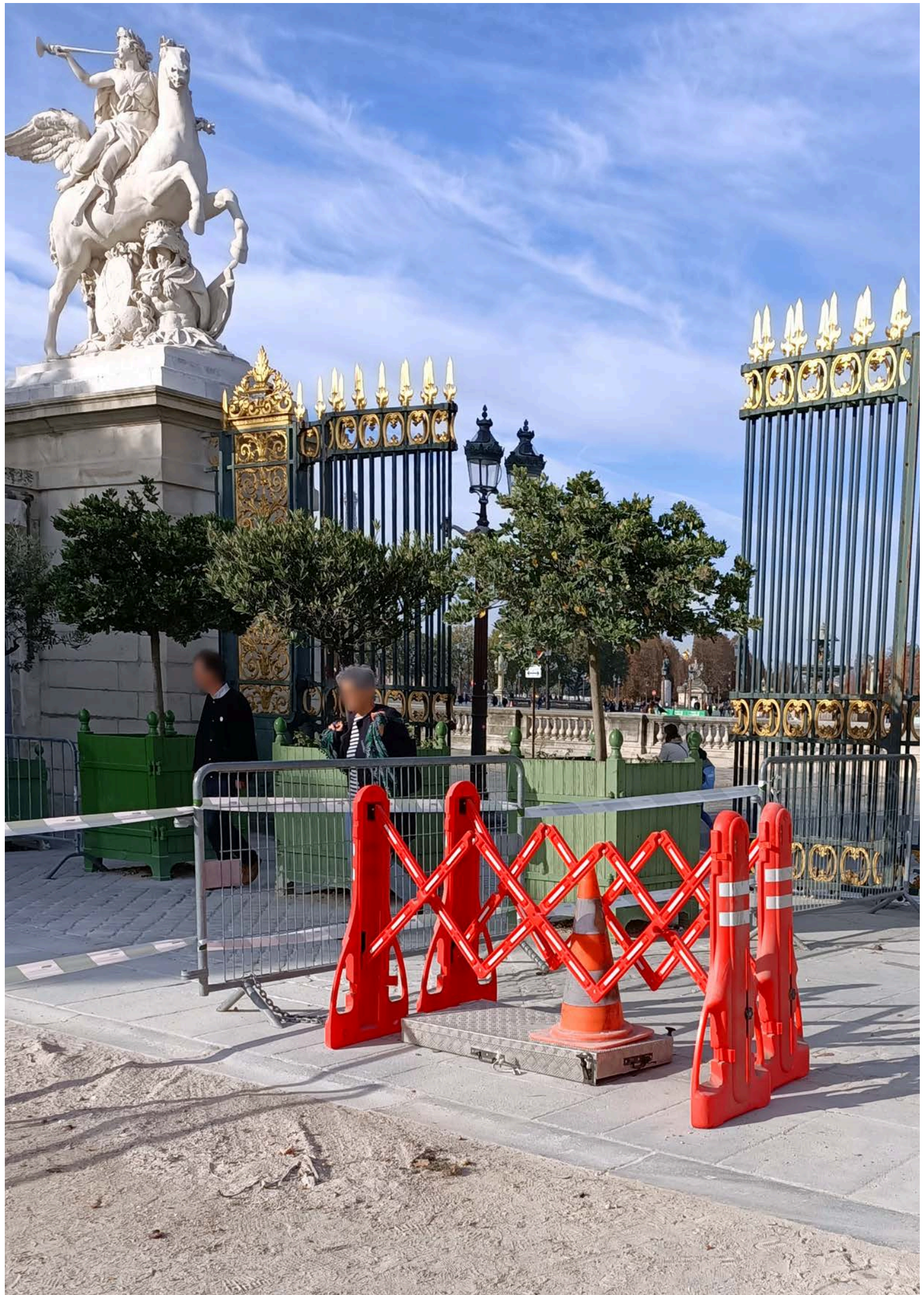



FLEXPLO

EXTENSIO

BARRIÈRE EXTENSIBLE ◦ **EXPANDABLE BARRIER**
BARRERA EXTENSIBLE ◦ **ABSPERR-SCHERENGITTER**



FLEXPLO ◀▶ 2,00 m

Code		
FLEXPLO 200 RB		4,80
FLEXPLO EXTRB		3,40
FLEXPLO 200 NJ		4,80
FLEXPLO EXTNJ		3,40

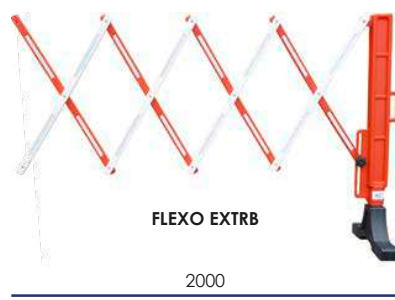
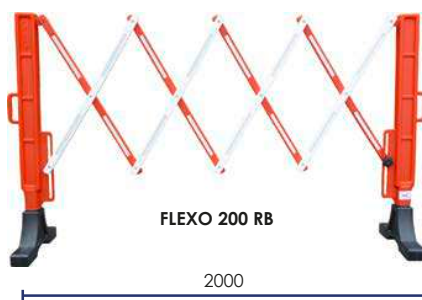
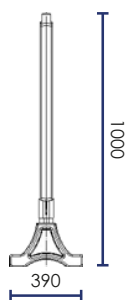

EXTENSIO ◀▶ 2,40 m

Code		
EXTENSIO		7,50
EXTENSIO JA		7,50

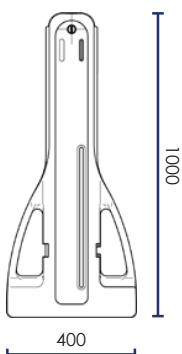
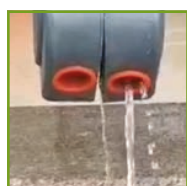

OPTION ◦ **OPTIONAL** ◦ **OPCIÓN** ◦ **OPTIONAL**

FLASH 90

LAMPSOL 180



BAR 3000

BARRIÈRE EXTENSIBLE ◦ EXPANDABLE BARRIER BARRERA EXTENSIBLE ◦ SCHERRENSPERREN

3,00 m



Code	
BAR 3000 RB	
BAR 3000 BK	
BAR 3 EXT RB	
BAR 3 EXT BK	

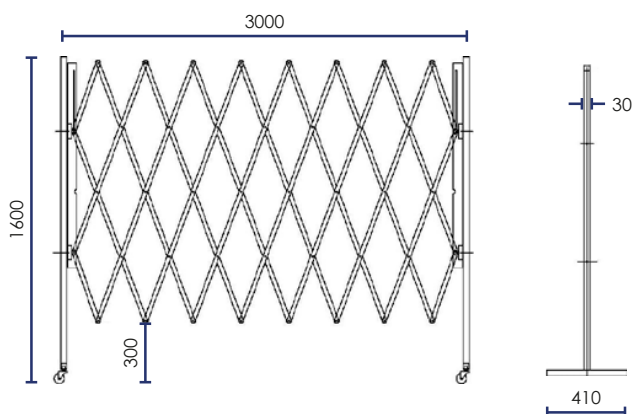
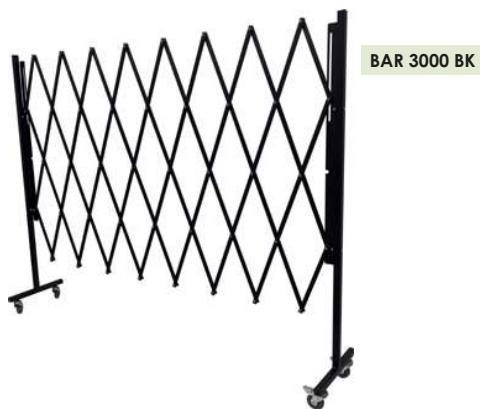

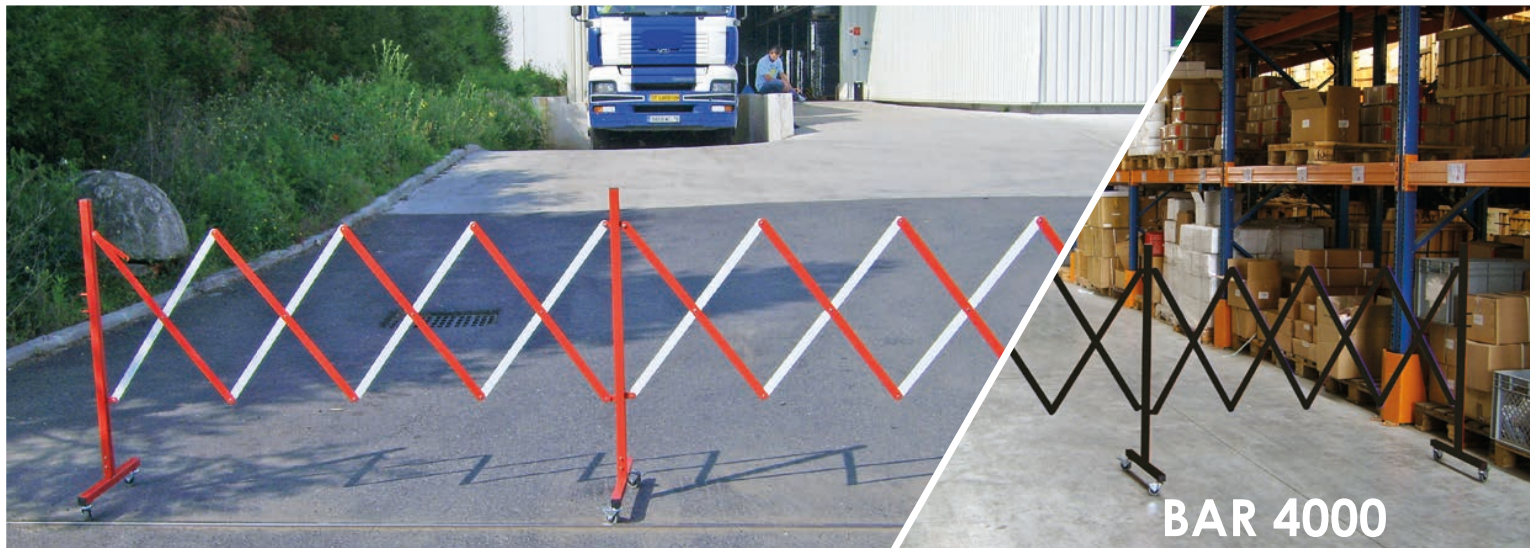

BAR 4000

BARRIÈRE EXTENSIBLE ◦ **EXPANDABLE BARRIER**
BARRERA EXTENSIBLE ◦ **SCHERRENSPERREN**

↔ 4,00 m



Code	
BAR 4000	
BAR 4000 NJ	
BAR 4000 BK	

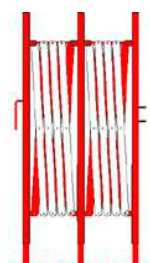

BAR 4000

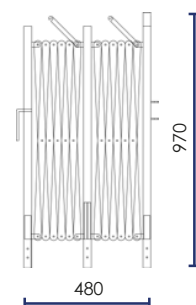
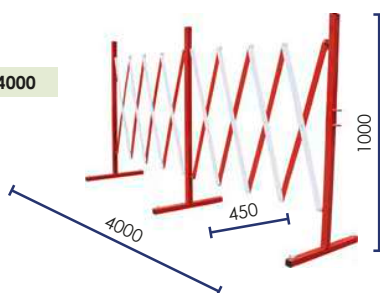

Code	
BAR 4000 FIX	
BAR 4000 NJ FIX	
BAR 4000 BK FIX	

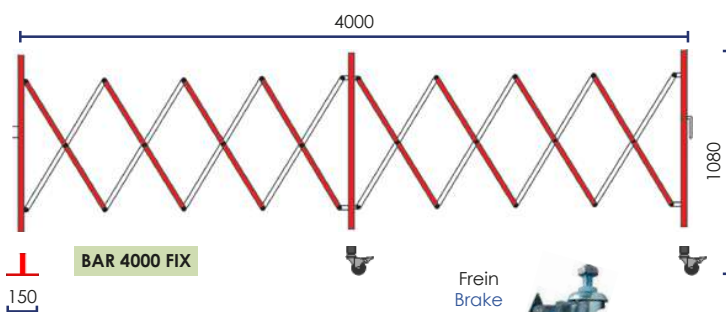

BAR 4000 FIX

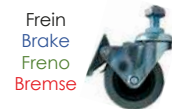

WH 501 SB
 Ø 50 mm

Code	
BAR 4006 RB	
BAR 4006 NJ	
BAR 4006 BK	



BAR 4006 RB

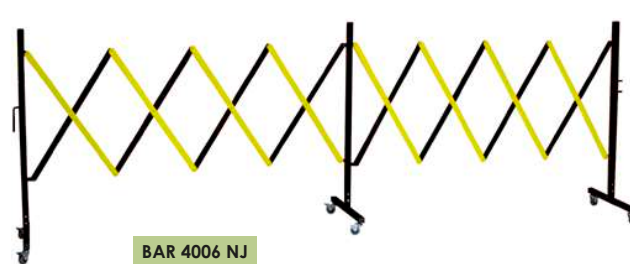

BAR 4006 NJ

OPTION ◦ **OPTIONAL** ◦ **OPCIÓN** ◦ **OPTIONAL**



Frein
 Brake
 Freno
 Bremse
 Ø 50 mm
 WH 501 SB

Kit de fixation murale ◦ Wall fixing kit
 Kit de fijación a la pared
 Wandbefestigungsset

BAR 4 KIT

coffee

COMPTOIR DES ARÔMES

SUCRE ET
TOUILLETTE
DISPONIBLES
EN CAISSE

PORT DU MASQUE
OBLIGATOIRE
Même de votre côté
DACS SANS SECOURS

NOTRE CARTE

TOUTES LES MIGNARDISES

À PRIX MINI

COMME LE PAIN
SANS CONTACT

FAITES VOS
ESCOMPTES

NOTRE CARTE

TOUTES LES MIGNARDISES

À PRIX MINI

COMME LE PAIN
SANS CONTACT

FAITES VOS
ESCOMPTES

NOTRE CARTE

TOUTES LES MIGNARDISES

À PRIX MINI

COMME LE PAIN
SANS CONTACT

FAITES VOS
ESCOMPTES

VISO

VISO

VISO

VISO

VISO

VISO



**PARAVENT
/ BARRIÈRE DE PROTECTION**

- Auto portante
- 2 hauteurs : 1 m ou 1,80 m
- En 3 vantaux
- Inox ou PVC
- Repliable
- Tissus à assembler sur l'armature par le client
- Tissu imprimé 1 face.
- Panneaux décoratifs avec velcro :
 - ▷ Facile à mettre en place
 - ▷ Facile à tendre
 - ▷ Tissus lavables
- Option
 - ▶ Tissu Ignifugé, impression 3 couleurs
 - ▶ Tissu brise vent, impression 3 couleurs
 - ▶ Autre couleur de Tissu (Mini. 15 barrières)
 - ▶ Personnalisation quadri (tissu standard)
 - ▶ Sac de transport

**SCREEN
/ PROTECTION BARRIER**

- Self Standing
- 2 heights: 1 m or 1.80 m
- In 3 panels
- Stainless steel or PVC
- Foldable
- Fabrics to be mounted on the frame by the customer
- 1 side printed fabric
- Decorative panels with velcro :
 - ▷ Easy to put in place
 - ▷ Easy to stretch
 - ▷ Washable fabrics
- Optional
 - ▶ Flame retardant fabric, 3 colors printing
 - ▶ Windproof fabric, 3 colors printing
 - ▶ Other color of Fabric (Mini 15)
 - ▶ Customization 4 colors (standard fabric)
 - ▶ Transport bag

**BIOMBO
/ BARRERA DE SEÑALIZACIÓN**

- Estructura autoportante
- 2 alturas: 1 m o 1,80 m
- De 3 paneles
- Acero inoxidable o PVC
- Plegable
- Armados de los tejidos en el marco por el cliente
- Tejido impreso a 1 cara
- Paneles decorativos con velcro:
 - ▷ Fácil de colocar
 - ▷ Fácil de tender
 - ▷ Tejidos lavables
- Opción
 - ▶ Tejido ignifugo impresión a 3 colores
 - ▶ Tejido cortaviento impresión a 3 colores
 - ▶ Otro color de tejido (Mini 15)
 - ▶ Impresión a 4 colores (tejido estándar)
 - ▶ Bolsa de transporte

**SCHUTZ BARRIERE
/ SICHTSCHUTZ**

- Freistehend
- Höhe : 1m oder 1,8m
- 3 Sicht- / Schutzfelder
- Ständer Ausführung in Stahl oder Kunststoff
- Faltbar
- Montage der Elemente vor Ort durch Kunden
- 1 Seite ist bedruckt.
- Bespannung mit Klettverschluss :
 - ▷ einfach zu montieren
 - ▷ ist dehnbar
 - ▷ waschbar
- Optional
 - ▶ Flammfestes Gewebe 3 Farben-Druck
 - ▶ Windiges Gewebe 3 Farben-Druck
 - ▶ Andere Farbversion (Mind. 15 Stück)
 - ▶ 4 Farben-druck (standard gewebe)
 - ▶ Transporttasche



ENR 200

BARRIÈRE AVEC ENROULEUR ◦ **EXPANDABLE / RETRACTABLE BARRIER**
BARRERA DE SEÑALIZACIÓN CON ENROLLADOR ◦ **EINZIEHBARE ABSPERROLLE**

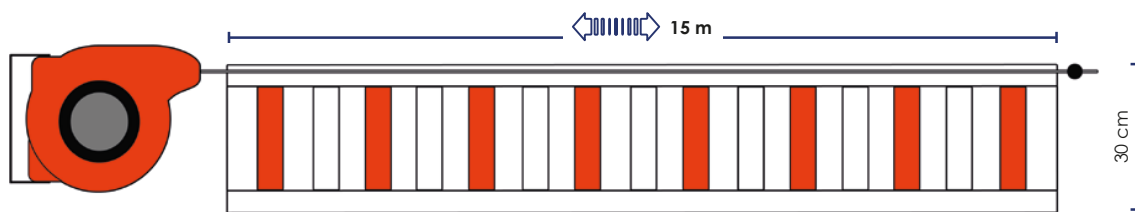

390 x 120 x 270  4,0



ENR 200 OR
 Réfléchissant
 Reflective
 Reflektivo
 Reflektierend

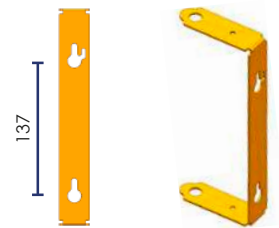

ENR 200 RB



ENR 200 NJ

INCLUS ◦ **INCLUDED**
INCLUIDO ◦ **INKLUSIVE**



OPTION ◦ **OPTIONAL** ◦ **OPCIÓN** ◦ **OPTIONAL**

ENR 200 ROUTE
 87 x 28 cm

ROUTE BARREE

ENR 200 ACCES
 87 x 28 cm

ACCES INTERDIT

ENR 200 SI
 29 x 27 cm





ENR 200

OPTIONS ○ **OPTIONS** ○ **OPCIONES** ○ **OPTIONEN**

ENR BOX

500 x 200 x H 480



Porte coulissante
Sliding door
Puerta corrediza
Schiebetürsystem



ENR POST 140



Poteau support et récepteur
Fixing post and receiver
Poste soporte y receptor
Doppelte Funktion: Träger und Empfänger

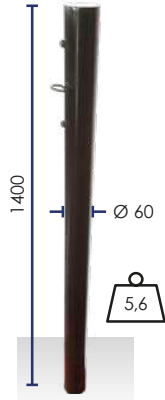

BASE 2500

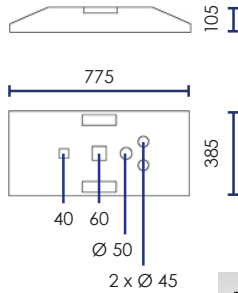

ENR 200 + BBASE

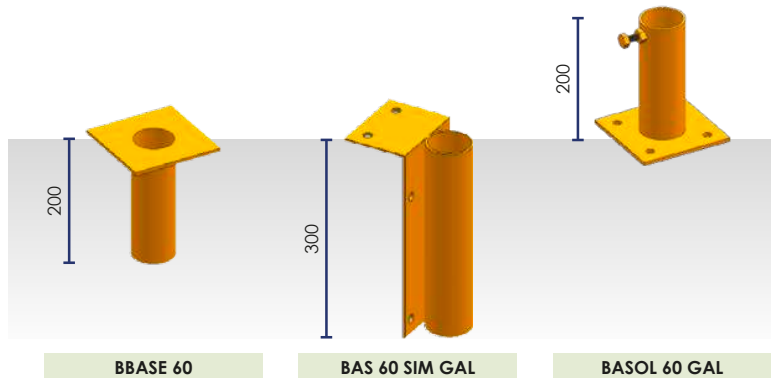

BBASE 60

BAS 60 SIM GAL

BASOL 60 GAL



RUBAN DE SIGNALISATION

WARNING TAPE ◦ CINTA DE SEÑALIZACIÓN ◦ ABSPERRBÄNDER



IMPRESSION 1 FACE ◦ 1 SIDE PRINTING ◦ IMPRESIÓN 1 CARA ◦ 1-SEITIG BEDRUCKEN

Code	
RSNA 01 RB	x 36
RSNA 121 RB	x 12
RSNA 01 NJ	x 36
RSNA 121 NJ	x 12
RSNA 01 VE	x 36
RSNA 121 VE	x 12

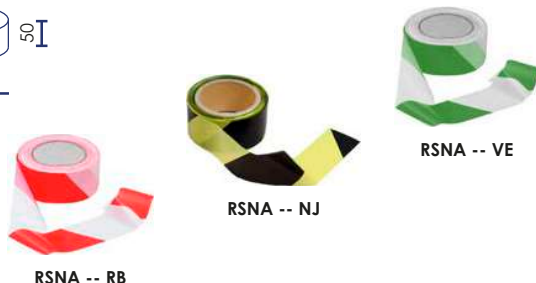
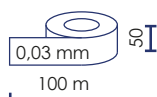

IMPRESSION 2 FACES ◦ 2 SIDES PRINTING ◦ IMPRESIÓN 2 CARAS ◦ 2- SEITIG BEDRUCKEN

Code	
RSNA 02 RB	x 36

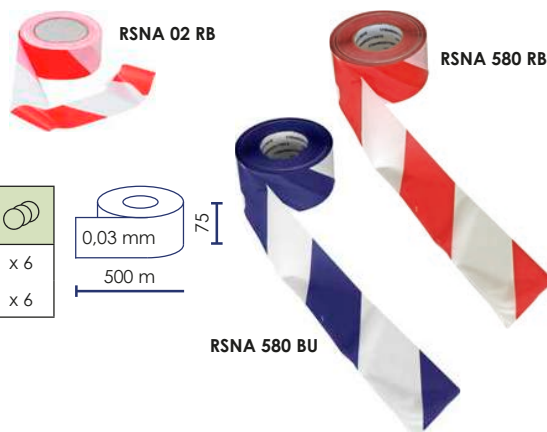
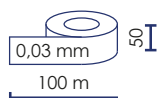

Code	
RSNA 580 RB	x 6
RSNA 580 BU	x 6

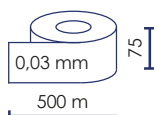

ACCESSOIRES ◦ ACCESSORIES
ACCESORIOS ◦ ZUBEHÖR

PFER 520 SB



SP 1205 SB

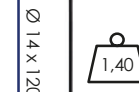

Ø 14 x 1200

CHAINE POLYPRO

POLYPROPYLENE CHAIN ◦ CADENA DE PLÁSTICO ◦ KUNSTSTOFFKETTEN



Code	
CFLUO 825 SBS	○
CNJ 801 SBS	●
CBR 801 SBS	●
CPB 801 SBS	○
CPR 801 SBS*	●
CBV 801 SBS	●
CBB 801 SBS	●
CPN 801 SBS	●

25 m - Ø 8



CFLUO 825 SBS



Accessoires ► p. 175
Accessories ► p. 175
Accesorios ► p. 175
Zubehör ► p. 175

* Epuisement stock ◦ While stock lasts ◦ Hasta agotar existencias ◦ Lagerverrat Begrenzung



BANDEAU DE SIGNALISATION TISSU ○ **HIGH VISIBILITY WARNING STRIP**
BANDA DE ADVERTENCIA ALTA VISIBILIDAD ○ **BAND MIT HOHER SICHTBARKEIT**



5 M



Bandes lestées
 Weighted bottom
 Bandas lastradas
 unten des Bands gewichtet

GUI 500 OR

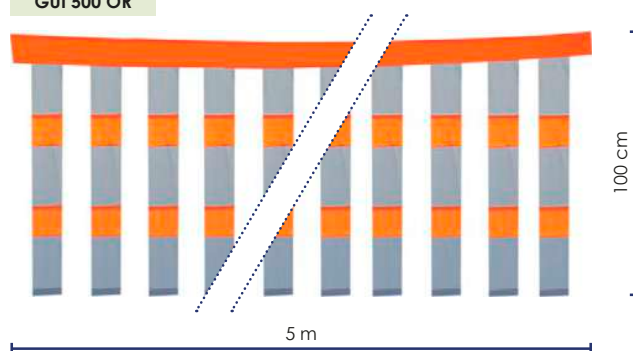

20 M



Bandes réfléchissantes
 Reflective tapes
 Tiras reflectantes
 Reflektierende Streifen

GUI 200 OR

CLASSE 1

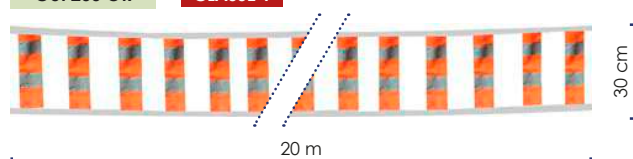

GUI 200 RB

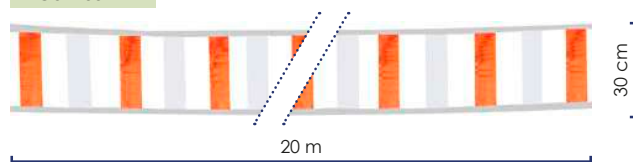

INCLUS ○ **INCLUDED** ○ **INCLUIDO** ○ **INKLUSIVE**



Sac de rangement
 Storage bag
 Bolsa de almacenamiento
 Aufbewahrungstasche

OPTION ○ **OPTIONAL** ○ **OPCIÓN** ○ **OPTIONAL**

ENR 200 ROUTE
 87 x 28 cm

ROUTE BARREE

ENR 200 ACCES
 87 x 28 cm

ACCES INTERDIT

ENR 200 SI
 29 x 27 cm





RSNT 100

RSA

RUBAN DE BALISAGE ◦ MARKING TAPE ◦ CINTA DE SEÑALIZACIÓN ◦ BODENMARKIERUNG

ADHÉSIF ◦ ADHESIVE ◦ ADHESIVO ◦ KLEBSTOFF

Code		
RSA 335 STOP NJ		x 6
RSA 335 NJ		x 6
RSA 335 RB		x 6

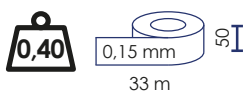

RSA 335 STOP NJ



RSA 335 NJ



RSA 335 RB



ANTI-DÉRAPANT ◦ NON SKID ◦ ANTIDESLIZANTE ◦ ANTIRUTSCH VERSION

Code		
RSA 550 BK		x 6
RSA 550 NJ		x 6
RSA 550 RB		x 6
RSA 550 BYB		x 6

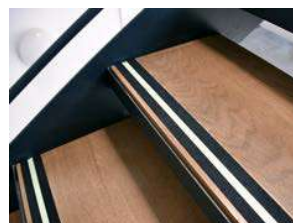
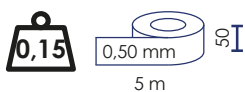

RSA 550 BYB



Code		
RSA 5100 BK		x 1
RSA 5100 NJ		x 1

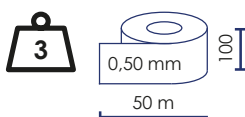

RSA 5100 BK

RÉFLÉCHISSANT ET ANTI-DÉRAPANT * ◦ NON SKID AND REFLECTIVE
REFLECTIVO Y ANTIDESLIZANTE ◦ REFLEKTIEREND & ANTIRUTSCH VERSION

Code		
RSNT 100 JA		x 1
RSNT 100 BL		x 1
PODGLUE2 *		

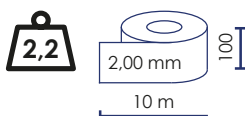

* A poser avec colle ◦ To fix with glue ◦ Usar pegamento ◦ Befestigung durch Kleber



Colle époxydique souple 2 composants pour béton
Flexible 2-component epoxy adhesive for concrete
Adhesivo epoxídico flexible de 2 componentes para hormigón
2-Komponenten Kleber für Beton





PDM

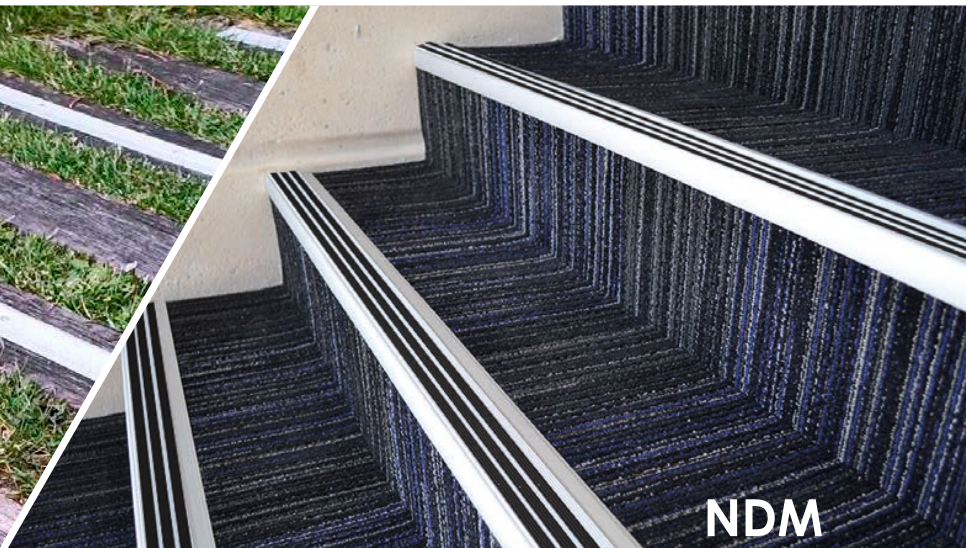

NDM

NEZ DE MARCHÉ ANTIDÉRAPANT ◦ NON-SLIP STAIR NOSING PERFIL ANTIDESLIZANTE PARA PELDAÑOS ◦ RUSTCHFEST TREPPENKANTENPROFIL



Code			
NDM 900 PVC	●	3 x 5 mm	0,80
NDM 900 BK	●		0,80
NDM 900 FLUO	●		0,80
NDM 1300 PVC	●	4 x 5 mm	1,20
NDM 1300 BK	●		1,20
NDM 1300 FLUO	●		1,20

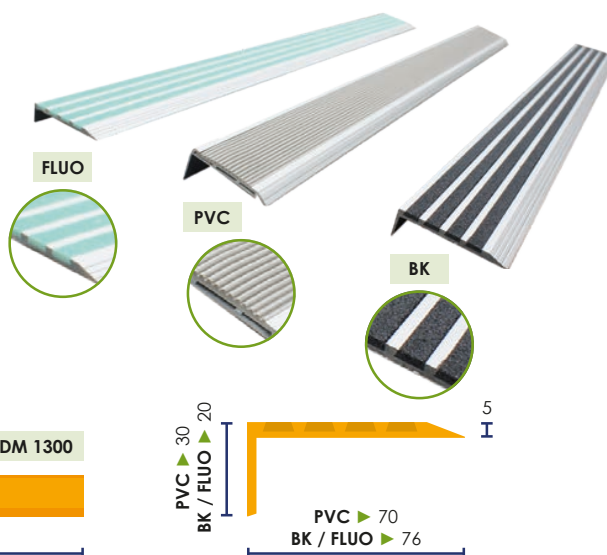

non fourni ◦ not supplied ◦ no incluido ◦ nicht enthalten

NDM 900



900

NDM 1300



1300

PLAT DE MARCHÉ ◦ STAIRS PAD PERFIL ANTIDESLIZANTE PARA PELDAÑOS ◦ TREPPENKANTEN



Code			
PDM 900 PVC	●	3 x 5 mm	0,80
PDM 900 BK	●		0,80
PDM 1300 PVC	●	4 x 5 mm	1,10
PDM 1300 BK	●		1,10

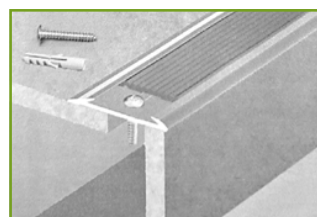

non fourni ◦ not supplied ◦ no incluido ◦ nicht enthalten

PDM 900



900

PDM 1300



1300

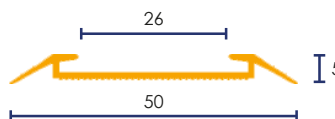

OPTION
OPTIONAL
OPCIÓN
OPTIONAL



RQ GLUE



SOLEX

ADHÉSIF POUR MARQUAGE AU SOL EXTÉRIEUR

OUTDOOR WARNING FLOOR STICKER

ADHESIVO DE MARCADO PARA USO EXTERIOR

BODENMARKIERUNGEN EXTERNE ANWENDUNG

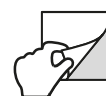

ANTI-DÉRAPANT

NON SKID ◦ ANTIDESLIZANTE ◦ ANTIRUTSCH VERSION



Impression sur vinyle adhésif antidérapant spécialement conçu pour asphalte, trottoirs ou béton.

Printing on non-slip adhesive vinyl specially designed for asphalt, sidewalks or concrete.

Impresión sobre vinilo adhesivo antideslizante especialmente diseñado para asfalto, aceras u hormigón.

Druck auf rutschfestem Klebevinyll speziell für Asphalt, Gehwege oder Beton.

SOLEX 560 HAND

600 x 500



SOLEX 500 STAT

Ø 500



SOLEX 500 OBLI

Ø 500



SOLEX 500 PIET

Ø 500



SOLEX 500 SENS

Ø 500



SOLEX 305 FLEC

30 x 5 cm

x 5

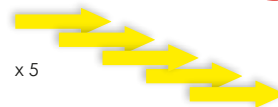

SOLEX 280 PAS

28 x 10 cm

x 10 (5 + 5)



SOLEX 845 PERS

80 x 45 cm

x 2



SOLEX 100 ZEBRA

100 x 25 cm

x 3



SOLEX 453 CHUT

45 x 35 cm



SOLEX 453 TOMB

45 x 35 cm





SAN 500



ADHÉSIF POUR MARQUAGE AU SOL INTÉRIEUR

INDOOR WARNING FLOOR STICKER

ADHESIVO DE MARCADO PARA USO INTERIOR

WARN- & VERBOTSSCHILDER BODEN INNENBEREICH

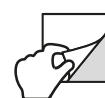

STANDARD

SOL 350 RSTOP

Ø 350



SOL 500 RCHAR

Ø 500



SOL 500 RFUM

Ø 500



SOL 500 RINT

Ø 500



SOL 500 ROBLI

Ø 500



SOL 500 RPIET

Ø 500



SOL 500 RSENS

Ø 500



ANTI-DÉRAPANT

NON SKID

ANTIDESLIZANTE

ANTIRUTSCH VERSION



SAN 500 TCHAR

500 x 500 x 500



SAN 500 TELEC

500 x 500 x 500



SAN 500 TGLIS

500 x 500 x 500



SAN 500 CEXT

500 x 500





WALL 1200



WARN 1200

RAMPE DE PORTAIL

GATE RAMP ◦ RAMPA DE ENTRADA ◦ EINFahrtschwelle vor einem Tor

CAOUTHOUC
RUBBER
CAUCHO
KAUTSCHUK

WARN 1200

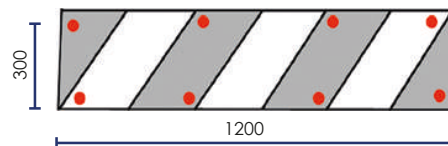

OPTION ◦ OPTIONAL ◦ OPCIÓN ◦ OPTIONAL



FSAFE
x 8



RQ GLUE

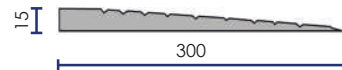

SIGNALISATION DE VIRAGE / PARKING

PARKING RAMP SIGN ◦ SEÑAL PARA APARCAMIENTO ◦ SIGNALISIERUNG

CAOUTHOUC
RUBBER
CAUCHO
KAUTSCHUK

WALL 1200



x 15
Réflecteurs
Eye cats
Refletores
Reflektoren

INCLUS ◦ INCLUDED ◦ INCLUIDO ◦ INKLUSIVE



x 6



x 15

